

OP 3D Vision

The upgradable 3D X-ray system for the strictest demands.



The solution for every task: KaVo OP 3D Vision.

Regardless of which dental query you may have, the KaVo ORTHOPANTOMOGRAPH™ OP 3D Vision X-ray system is the answer. Thanks to the high 3D precision and flexible planning and application tools, the three upgradable versions will exceed your expectations for almost all requirements. Whether it is for implantology, surgery, endodontics, TMJ, respiratory path analysis or orthodontics. Even with complex indications, a quick diagnosis and simple creation of treatment plans is ensured.

OP 3D Vision

OP 3D Pro

OP 3D

OP 2D

Based on the technology of i-CAT™ systems – awarded with numerous international prizes for innovation and technology:



Your benefits at a glance:

- Upgradable device: three options for all your clinical needs – now and in the future
- QuickScan+ for 3D X-ray exposures with only 4.8 seconds cycle time and ultra low radiation dose
- Visual iQuity™ for optimised 3D image quality and clarity
- SmartScan STUDIO™ touchscreen for quick and simple operation with user-friendly operating concept
- Ergonomic Stability System (ESS) offers stable patient positioning and prevents motion artifacts

Image quality with less radiation: Low Dose Technology™ with QuickScan+.

With the QuickScan+ option, you can create 3D X-ray volumes with good image quality in terms of diagnosis at a highly reduced dose when compared with standard 3D exposures. This function is ideal for sensitive X-ray scenarios, such as post-op exposures, implant planning and exposures of children. The QuickScan+ exposures, with just 4.8 seconds scan time, are available after roughly only 30 seconds reconstruction time.

QuickScan+ (ultra low dose) image quality



Standard mode image quality

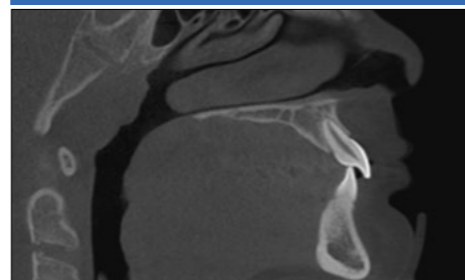

KaVo OP 3D Vision – dose of adult phantom*

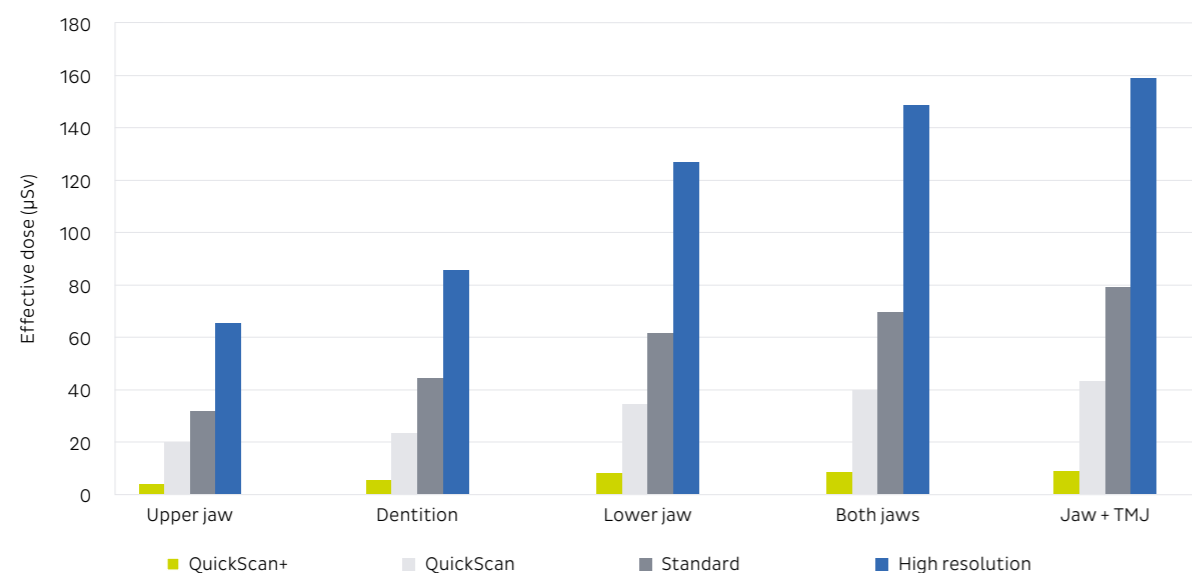

* From the study "Phantom dosimetry and image quality of i-CAT™ FLX CBCT".
John. B. Ludlow, University of North Carolina, School of Dentistry, 2013

Image quality: A question of technology.

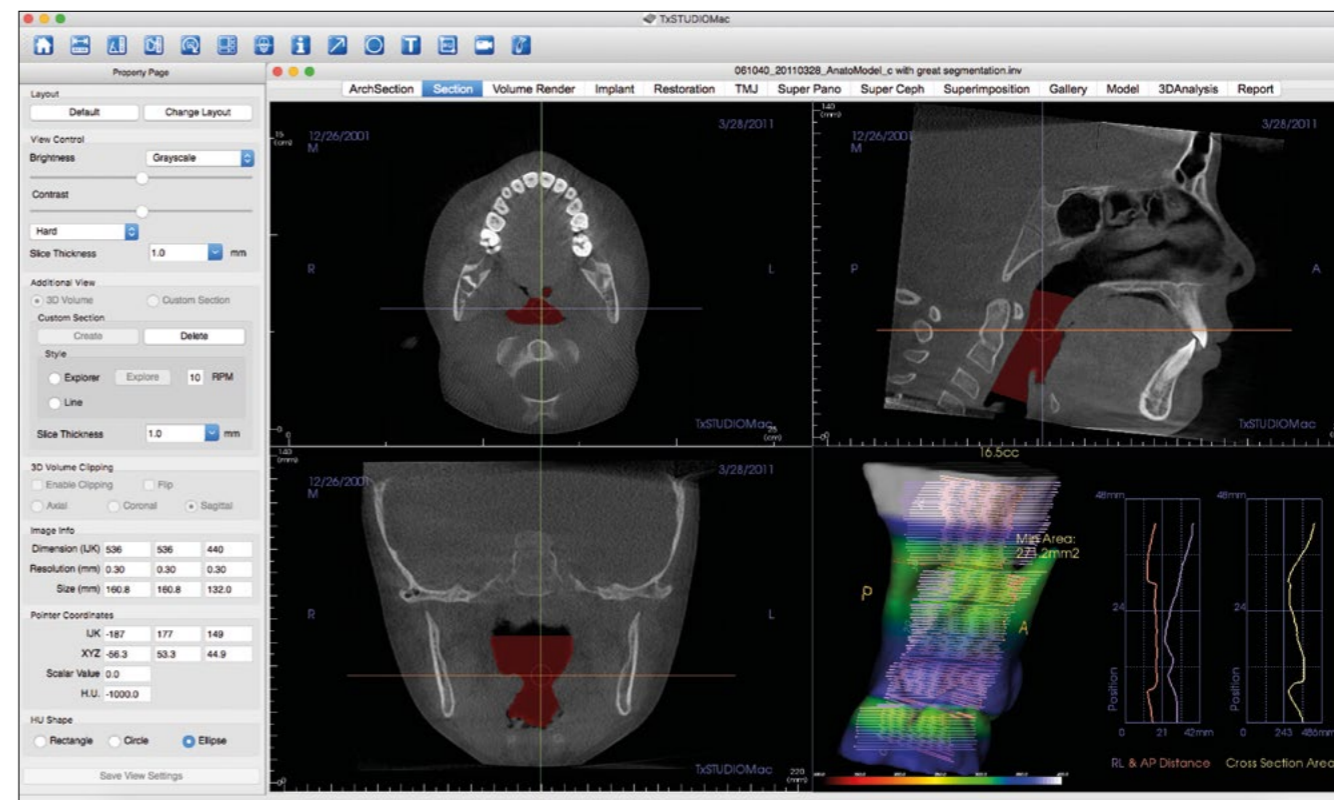

3D images with outstanding clarity.

Visual iQuity™ uses specific algorithms for image optimisation. This ensures exposures with a high degree of sharpness and clarity.

Stable patient positioning.

The Ergonomic Stability System (ESS) ensures a very high level of comfort when taking exposures. With positioning aids such as light markers and a secure head fixation, loss in quality due to motion artifacts is minimised from the outset.

Broad variety of clinical options.

Selectable voxel sizes from 0.125 mm to 0.400 mm allow for personalised, indication-based determination of quality and dose according to the requirements relevant to diagnosis.

Flexibility with nine volume sizes.

The KaVo OP 3D Vision, with 9 FoV sizes and various low-dose settings, offers great flexibility when choosing the exposure mode. With volume sizes from 5 x ø 8 cm, 4 to 13 x ø 16 cm, up to 17 x ø 23 cm, you have a wide range of options. You can choose between three upgradable versions, based on true clinical needs: V8 includes volume sizes 5 x and 8 x ø 8 cm. V10 offers additionally 4 x, 6 x, 8 x and 10 x ø 16 cm. V17 gives you the whole portfolio including 11 x and 13 x ø 16 cm as well as 17 x ø 23 cm.

An investment that grows with your practice.

Start with the right machine for your practice, and upgrade when you are ready to grow into new areas. The KaVo OP 3D Vision upgradable platform makes moving to a larger field-of-view seamless.

Available on all systems: 2D Pan.



The i-PAN feature allows you to take a quick 2D pan using the same high quality sensor that is used to acquire 3D scans. Coupled with software improvements to enhance overall 2D image quality, you can confidently use your KaVo OP 3D Vision for both your 2D and 3D imaging.

- V8** Ideal for implants, endodontics and most general dentistry.
- ▼
- V10** Ideal for implants, periodontics, prosthodontics, airway assessment, TMJ and most OMS.
- ▼
- V17** Most flexibility and image sizes for all 3D needs including orthodontics and orthognathics.



V8	✓	✓	Available with upgrade	Available with upgrade	Available with upgrade	Available with upgrade	Available with upgrade	Available with upgrade	Available with upgrade
V10	✓	✓	✓	✓	✓	✓	Available with upgrade	Available with upgrade	Available with upgrade
V17	✓	✓	✓	✓	✓	✓	✓	✓	✓

For every indication, the perfect images for precise diagnosis and effective treatment.

Implantology:
High-precision implant plans.

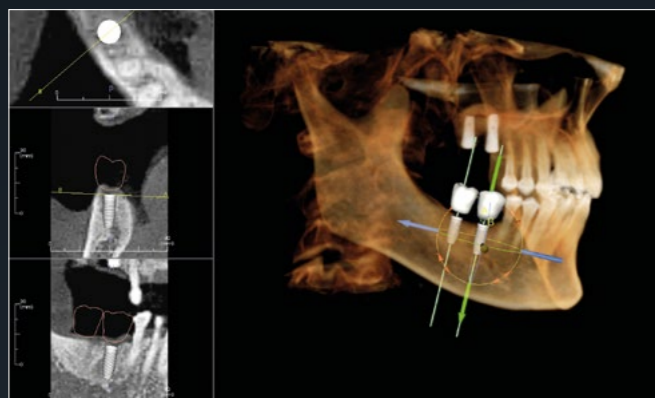

High-resolution CBCT exposures with complete 3D views permit an unrestricted assessment of the bone structure and tooth positions. This means the entire treatment plan can be executed, from inserting the implants and abutments through to delivery.

Oral and MJF surgery:
defining surgical treatment plans.



For position determination of displaced teeth in the alveolar bones, as well as their proximity to teeth or vital structures. Support with the detection of disorders such as cysts, tumors, lesions or pathological jaw changes for the avoidance of surgical complications.

Orthodontics:
Treatment plans with greater precision.

Better understanding of the exact tooth positions and anatomical circumstances allow for the creation of the least-possible invasive treatment plans for the best-possible result. The correct determination of the tooth axes and the identification of surplus teeth and their position simplifies the communication in maxillary surgery and prevents additional surgical measures. Additional application modules such as 3D teleradiographic measurements, virtual studies and impression-free models increase performance. All essential information is available with just a 4.8 second long, low-dose CBCT exposure.



Endodontics: Root assessment
in three dimensions.



For detailed examinations, high-resolution DVT exposures can be used for diagnosis, and observed axially and buccally/lingually with the application software. This allows full assessment of, for example, fractures, root canals and endo-perio lesions.

Gnathology:
Individual mandibular joint diagnosis.

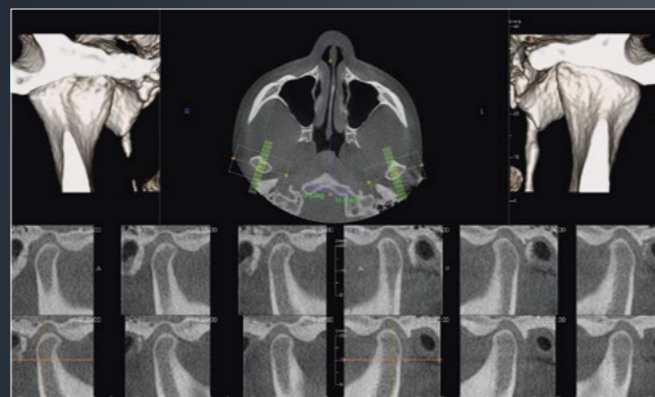

The task: to diagnose mandibular joint anomalies and to develop effective treatment procedures. The solution: With the TMJ display, defects, fractures and wear can be better identified and treated quickly with special, optional software applications.

Respiratory passage analysis:
Visualisation of restricted airways.

The software applications that come with KaVo OP 3D Vision offer 3D views for visualising obstructions to the airways by means of precise measurements to enable the best-possible treatment. A quick overview on the monitor allows for the measurement and calculation of paranasal sinus conditions for determining treatment options.

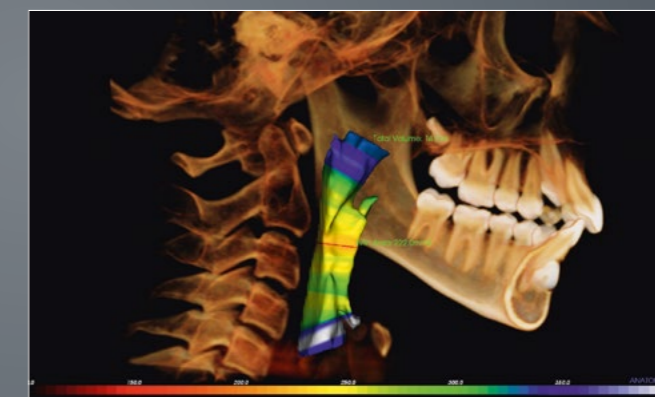

All the images on this double-page were created with the software InVivo; but can also be created (depending on image database compatibility) with, for example, OnDemand3D™.

Clear depiction, simple operation: SmartScan STUDIO™ touchscreen.

A finished exposure in four steps: The SmartScan STUDIO™ operating concept makes the operation simple and quick. Fewer user interfaces with large, clear symbols simplify the selection of exposure parameters. The programming of frequently used exposure modes (Quickpicks) also reduces the amount of operating steps necessary. The optionally available preview function (ScoutView) allows for precise selection of volume size and position.

1 Patient selection

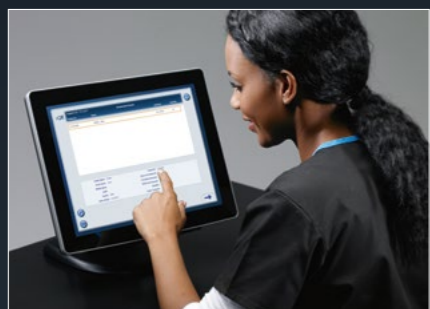

2 Exposure mode selection (Quickpick)



3 Exposure



4 Image evaluation



Your advantages:

- Quick and easy to learn
- Quickpick for personalized programming
- Only four operating steps until completed exposure
- ScoutView for the highest level of safety

The selection for your requirements: Software applications.

Required: InVivo – the performance package.

The software solution for 3D image evaluation and analysis, implant planning and drilling template planning and service.

- Implant planning module
- Implant library
- Drilling template planning
- 3D respiratory passage analysis
- Measurement and processing tools
- Analysis and reporting function
- 3D volume rendering for patient discussions and presentations
- 3D analysis

Optional: OnDemand3D™ – more efficiency.

The X-ray software for professional 3D image evaluation with applications from sophisticated 3D image evaluation to implant planning to drilling template planning.

- Indication-based planning and processing display
- Large manufacturer-related implant library
- Efficient implant planning
- Precise surgical intervention preparation
- Impressive 3D volume rendering for patient discussions and presentations
- Comprehensive measurement and processing tools
- Efficient analysis and reporting function
- Optional add-on modules (e.g. Fusion, In2Guide™)
- KaVo digital workflow components



The present: full diagnostics.
The future: integrated workflow.

The SmartScan STUDIO™ acquisition workflow software will be installed with your OP 3D Vision. For 3D diagnostics you can choose between OnDemand3D™ or InVivo™. In addition you are already prepared to use the new DTX Studio™* unifying software platform for 2D and 3D diagnostics, opening up a whole new era of digital workflow integration.

Your KaVo OP 3D Vision is ready for the future: With DTX Studio™*, a new software platform is coming. Designed as an end-to-end workflow system with a constant stream of new enhancements, the DTX Studio™ platform will cover all fields of modern

dentistry and dental technology in the future. The DTX Studio™ software is compatible with Mac and Windows operating systems. It will integrate both existing and future devices of multiple brands as well as current software provisions into one unified working process.

DTX Studio™.
Single workflow.

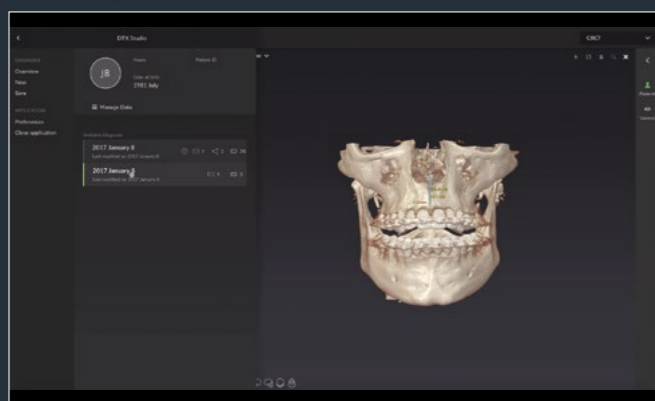

Screen with multiple diagnosis workspaces.

DTX Studio™.
Flexible integration.



Screen in 3D diagnostic workspace.

* Installations possible as soon as DTX Studio™ platform is available in your region.

Technical specifications.

X-ray tube assembly	High-frequency, constant potential, 90–120 kVp, 3–8 mA (pulsed)
Beam profile	Cone beam
Tube focal point	0.5 mm
Image receiver	Amorphous silicon flat panel, 20 x 25 cm
Voxel size	125 µm–400 µm
Acquisition time	4.8 s–26.9 s
Volume size (H x Ø cm)	V8: 5 x and 8 x 8. V10 additionally: 4 x, 6 x, 8 x, and 10 x 16. V17 additionally: 11 x and 13 x 16 and 17 x 23.
DICOM* support	Yes
Grayscale	16 bit acquisition
Collimation	Automatic
Patient position	Sitting
Reconstruction time	Less than 30 seconds (QuickScan+)
Normal image file size	< 50 MB
IT infrastructure requirements	A network connection to a practice server is required for storing the volume data. OnDemand3D™ Dental or another piece of 3D software can be used for 3D diagnosis and treatment planning software. Please note the hardware requirements for the 3D software. The SmartScan STUDIO™ administration software requires a PC with Windows 7 or higher.

* DICOM is the registered trademark of the National Electrical Manufacturers Association for their standard publications on the digital exchange of medical data.

Dimensions.

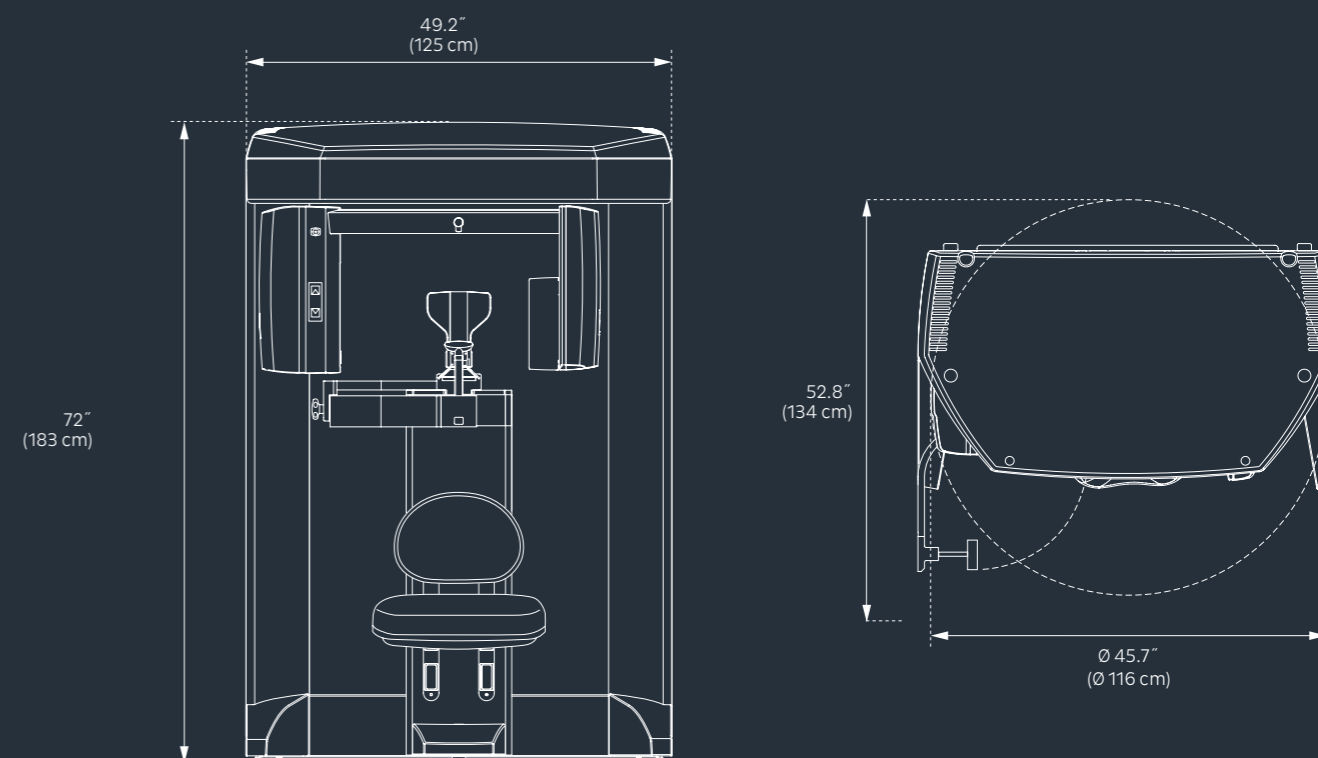

Dental Excellence in every area.



Practice equipment

KaVo treatment units and lights, dental chairs, patient communication systems, dental microscope and additional operator accessories.



Instruments

Dental straight and contra-angle handpieces, turbines, air polishing systems and small equipment for all application areas including diagnosis, prophylaxis, restorative, surgery, endodontics and instrument care.



Imaging

Intraoral X-ray equipment, sensors and imaging plate systems, panoramic and cephalometric in combination with CBCT, as well as dedicated CBCT devices for every indication in dentistry.



CAD/CAM

Dental CAD/CAM solutions for premium aesthetic, natural-looking and long-lasting restorative work, suitable for dentists and dental technicians.

The products, features, and services shown and described in this catalogue are not available in all countries. All specifications were correct at the time of publication. KaVo Dental GmbH assumes no liability for deviations in colour or form from the illustrations, mistakes or printing errors and reserves the right to make changes to the brochures at any time. Reprinting, even just of excerpts, is only permitted with the consent of KaVo Dental GmbH.

ORTHOPANTOMOGRAPH™, OP™ and Low Dose Technology™ are either registered trademarks or trademarks of KaVo Kerr Group Finland in the United States and/or other countries. i-CAT™, Visual iQuity™ and SmartScan Studio™ are either registered trademarks or trademarks of Dental Imaging Technologies Corporation in the United States and/or other countries. KaVo™ is either registered trademark or trademark of Kaltenbach & Voigt GmbH in the United States and/or other countries. All other trademarks are property of their respective owners.

Palodex Group OY | Nahkelantie 160 | FI-04300 Tuusula | Finland
www.kavokerr.com

KaVo Dental GmbH | Bismarckring 39 | 88400 Biberach | Germany
www.kavo.com

KAVO
Dental Excellence